

CXM Series

AIR-OPERATED DOUBLE-DIAPHRAGM PUMPS | PRODUCT BROCHURE



ALMATEC

Where Innovation Flows

Thanks to the modular design the Almatec® CXM series AODD pumps are available in four sizes with NPT and in three sizes with BSP connections. This wide range of product connections allows a precise adjustment of the pump to the specific application. This is reinforced by the alternative choice between a ball and cylinder valve system, which can also be converted to each other. Ball valves are ideal for liquids containing particles, cylinder valves for superior suction lift. The pumps are widely used as universal pumps in the low to middle performance range, e.g. as drum or IBC pumps.



MODULAR DESIGN
WITH SEVEN MODELS
FOR YOUR
PUMP REQUIREMENT

Almatec® CXM Series AODD Pumps for Low- to Middle-Duty Applications

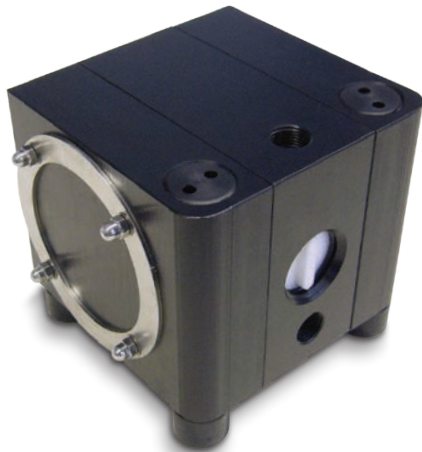

- Air-operated double-diaphragm pumps for low- to middle-performance ranges
- Modular design with seven different product connections: Four sizes with NPT connections and three sizes with BSP connections
- High pump safety due to innovative ring-tightening structure, design protected
- Flow optimizations in the product channels
- Made of conductive polyethylene (ATEX and FDA compliant), machined from solid blocks
- Air control system PERSWING P® without dead spot (no stalling)
- Diaphragms made of EPDM, NBR or PTFE/EPDM compound
- Ball or cylinder check valves
- Variable center blocks for different port sizes and positions
- Self-priming, can run dry
- Suction can empty containers of virtually all fluid

High Pump Safety

The housing parts of the CXM series are tightened to each other via housing bolts. However, instead of single bolts pressing punctually against the housing, all housing bolts are tightened together against a diaphragm-sized ring per side. This structure transmits the forces of the housing bolts into the housing parts evenly.

A consistent flow of forces and an increased bolt torque are the effect of this construction – ultimately increasing pump safety.

CXM Series | Special Features

Flow optimizations in the product channels ensure high performance and gentle pumping. CXM pumps are self priming and proof against dry running. They allow containers to be emptied down to the very last drop, even without supervision.

The housings are made of conductive PE, machined from solid blocks, which has a good overall chemical resistance. CXM pumps can be operated within explosion-proof areas and can handle flammable liquids (ATEX compliant). Pumps with PTFE internals also meet the FDA requirements.

The diaphragms used consist of one part only and are designed for a long service life. The Almatec air control system PERSWING P® is operating without any lubrication and has no dead center, important for reliable operation in demanding applications (e. g. on-off-mode at low speed).

Flexible Choice of Product Connections

Four pump sizes with NPT and three pump sizes with BSP connections are available. The NPT pump sizes 10, 20, 50 and 130 are drop-in interchangeable with the predecessor series CX and CXR. The position of the suction and discharge ports can be changed by rotating the center block. The product connections of the BSP pumps sizes 25, 55 and 135 are located on the face side of the pump. The sizes and the connection style at a glance:

- CXM 10 = NPT 3/8"
- CXM 20 = NPT 1/2"
- CXM 50 = NPT 3/4"
- CXM 130 = NPT 1 1/4"
- CXM 25 = BSP 1/2"
- CXM 55 = BSP 1"
- CXM 135 = BSP 1 1/2"

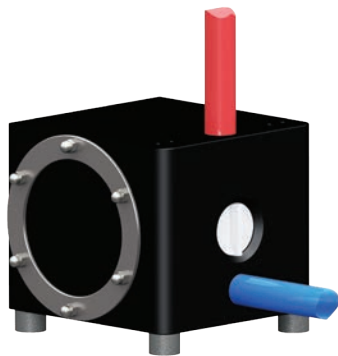

CXM 10
CXM 20
CXM 50
CXM 130

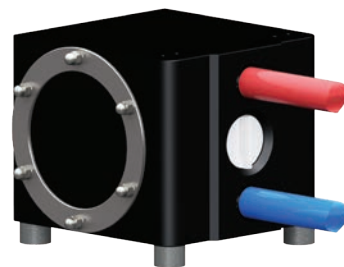

CXM 25
CXM 55
CXM 135

Code System

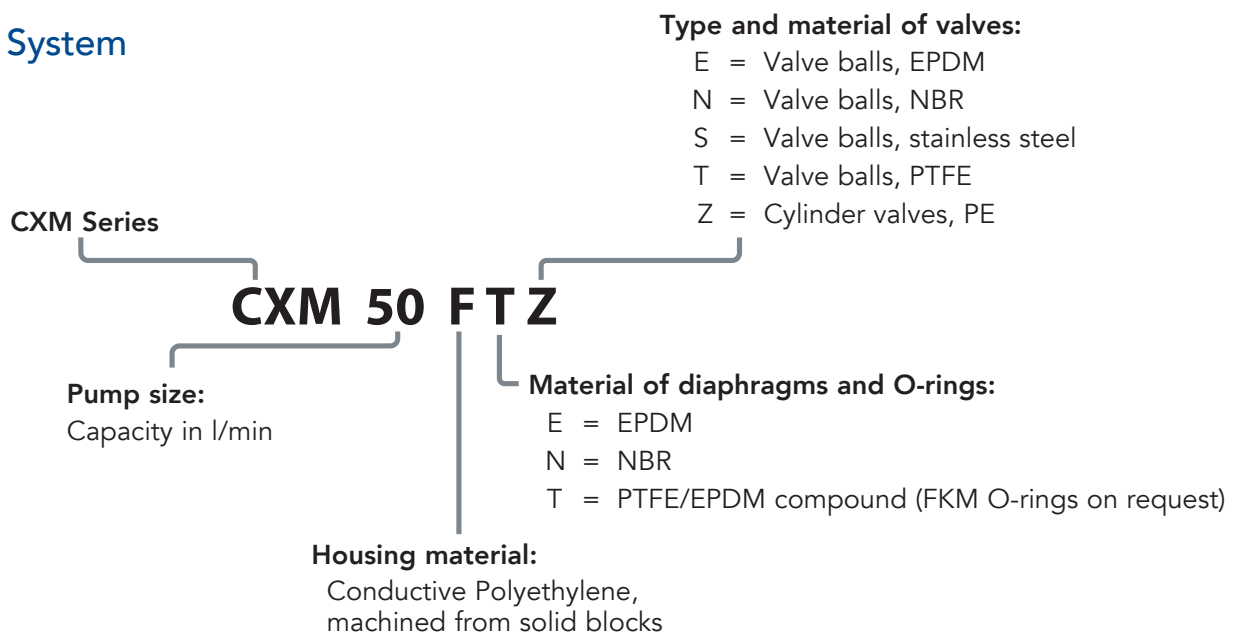

CYLINDER VALVES

(Choice "Z" in the pumpe code)

- Close gently and uniformly
- Very good dry priming values
- Material: PE



DIAPHRAGMS

- Integrated metal core, no diaphragm disc
- Designed for long service life
- Available materials:
 - EPDM
 - PTFE/EPDM compound
 - NBR



CENTER BLOCK

- Solid construction
- Material: Conductive Polyethylene (PE)



BALL VALVES

(Choices E/N/S/T in the pump code)

- Robust and insensitive to solids
- Form a linear seal with the valve seat
- Available materials:
 - EPDM
 - PTFE
 - NBR
 - Stainless steel

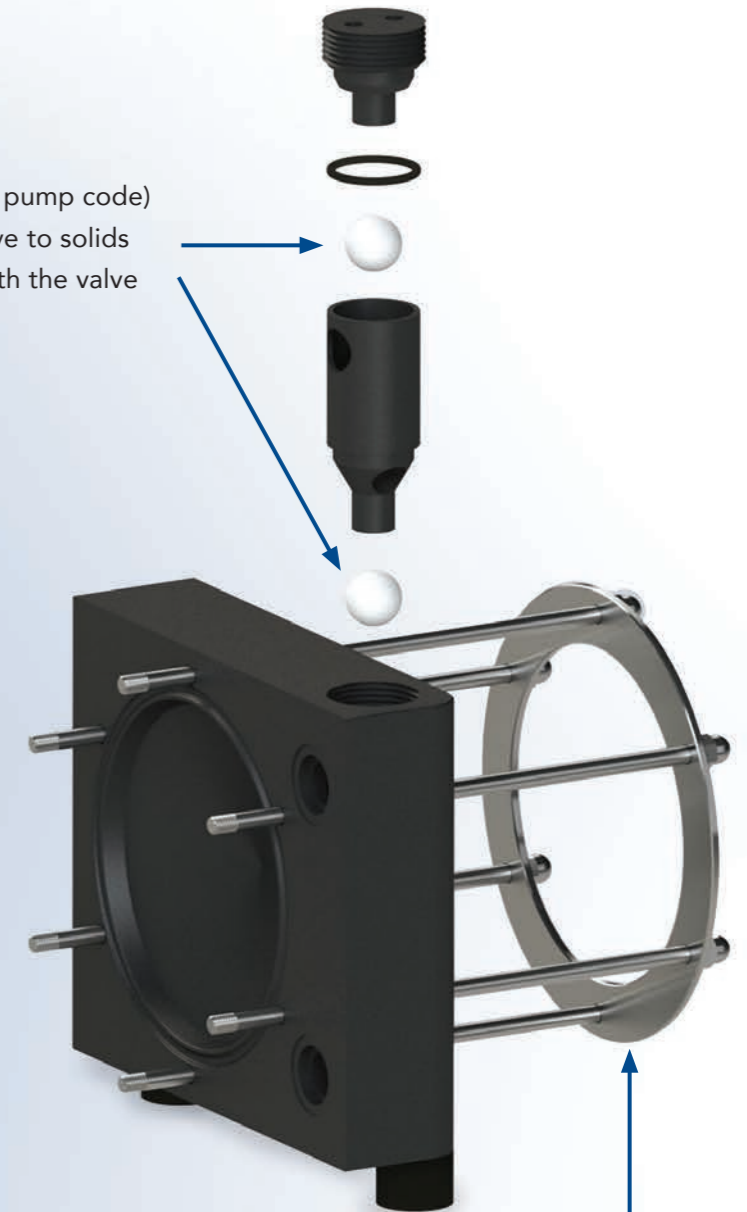

SIDE HOUSINGS

- Solid construction
- Wetted housing part
- Material: Conductive Polyethylene (PE), abrasion resistant, ATEX conform



PERWING P® AIR CONTROL SYSTEM

- Accurate reversal of the main piston
- Metal-free, low noise level
- No dead center
- Easy replacement of the complete cartridge

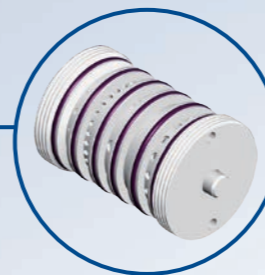

CONSTRUCTION RINGS

- Tightening of the side housings and center block via housing bolts
- No punctual load from bolts on to the housing
- Collective pressing via a diaphragm-sized ring on both sides
- Consistent flow of forces and increased bolt torque
- High level of pump safety

CXM Series | Technical Data

Pump Size		CXM 10	CXM 20	CXM 25	CXM 50	CXM 55	CXM 130	CXM 135
Dimensions- mm (inch):	Length	86 (3.4)	124 (4.9)	124 (4.9)	175 (6.9)	180 (7.1)	240 (9.4)	245 (9.7)
	Width	135 (5.3)	151 (5.9)	151 (5.9)	201 (7.9)	201 (7.9)	265 (10.4)	265 (10.4)
	Height	90 (3.5)	123 (4.8)	123 (4.8)	167 (6.6)	167 (6.6)	217 (8.5)	217 (8.5)
Nominal port size		3/8" NPT	1/2" NPT	1/2" BSP	3/4" NPT	1" BSP	1 1/4" NPT	1 1/2" BSP
Air connection		1/4" BSP	1/4" BSP	1/4" BSP	1/4" BSP	1/4" BSP	1/4" BSP	1/4" BSP
Weight	kg (lb)	1 (2.2)	1.8 (3.8)	1.8 (3.8)	4.7 (10.4)	4.7 (10.4)	11 (24)	11 (24)
Max. driving air pressure	bar (psig)	7 (100)	7 (100)	7 (100)	7 (100)	7 (100)	7 (100)	7 (100)
Max particle size of solids for pumps with ball valves	mm (in.)	1.5 (0.06)	2 (0.08)	2 (0.08)	3 (0.12)	3 (0.12)	4 (0.16)	4 (0.16)
Suction head, dry								
Cylinder valves	mWC (ft)	0.7 (2.3)	2 (6.6)	2 (6.6)	4.5 (14.8)	4.5 (14.8)	4.5 (14.8)	4.5 (14.8)
		Ball valves	0.5 (1.6)	1 (3.3)	1 (3.3)	2 (6.6)	2 (6.6)	3 (9.9)
Suction head, wet	mWC (ft)	8 (26.3)	8 (26.3)	8 (26.3)	9 (29.5)	9 (29.5)	9 (29.5)	9 (29.5)
Max. operating temperature	°C (°F)	70 (158)	70 (158)	70 (158)	70 (158)	70 (158)	70 (158)	70 (158)
Max. capacities	m ³ /h	0.7	1.6	1.6	3.3	3.3	7.5	7.8
	l/min	10	25	25	55	55	125	130
	gpm	3	7	7	15	15	33	34

Drum Pump Kit for Almatec® CXM 20 and CXM 50

The Kit is a sensible complement to the pump scope, as the characteristics of CXM pumps have traditionally been very suitable for the usage as drum pump, as CXM pumps offer:

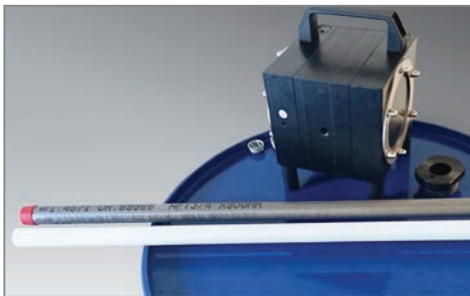

- Flexible applicability for numerous fluids
- Suction connection at the bottom side for positioning on top of the drum
- Low weight and handy dimensions
- High flow rate compared to pump size
- Self-priming capability
- Dry-run capability
- Intrinsic safety

Almatec offers the Drum Pump Kit for the sizes CXM 20 and CXM 50 in two versions, one dedicated as an adder to new pumps (FSP), the other as a retrofit to be used with existing pumps (FS). Furthermore, there is a choice of two different materials for the suction pipe (PE and stainless steel).

Pump and Drum Pump Kit form a new functional unit. This new unit does therefore not include ATEX-conformity (neither with suction pipe in stainless steel). However, drum pump applications do often not require ATEX.

Both versions are designed to be used on drums with a 2" bung hole and the kits contain a suction pipe of 900 mm length, a guiding piece with drum venting and higher damping feet for secure stand of the pump above the bung hole. The version for a new pump does as well include a convenient carrying handle fixed to the new pump.

Example for the type code:

Version:

FS = Kit for retro-fit

FSP = Kit for new pump

FSP for CXM

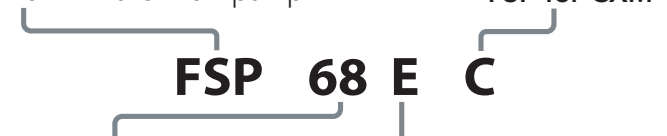

Connection:

48 – 1/2" (for CXM 20)

68 – 3/4" (for CXM 50)

Suction Pipe:

E = PE

S = Stainless Steel

CXM Series Pump | Performance Charts

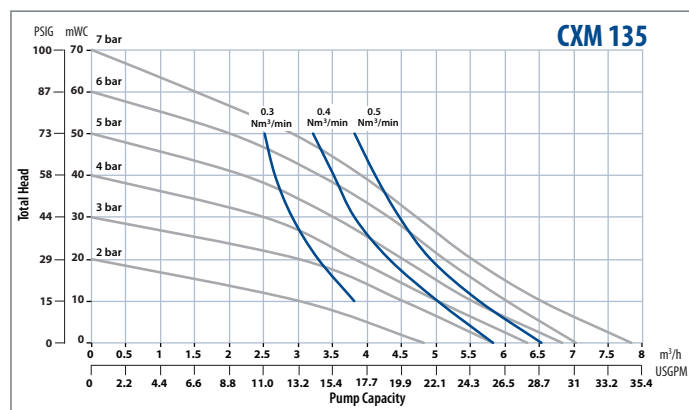
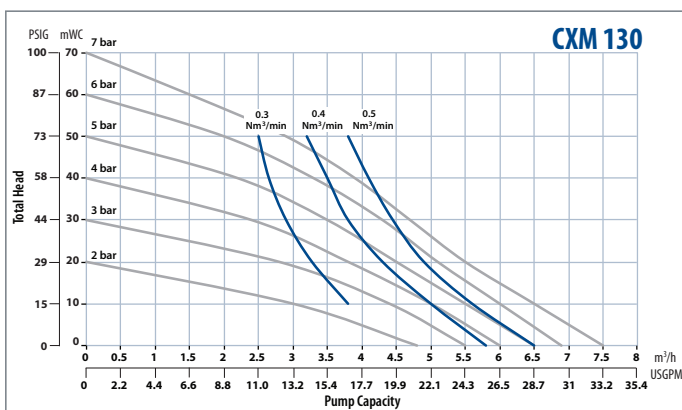
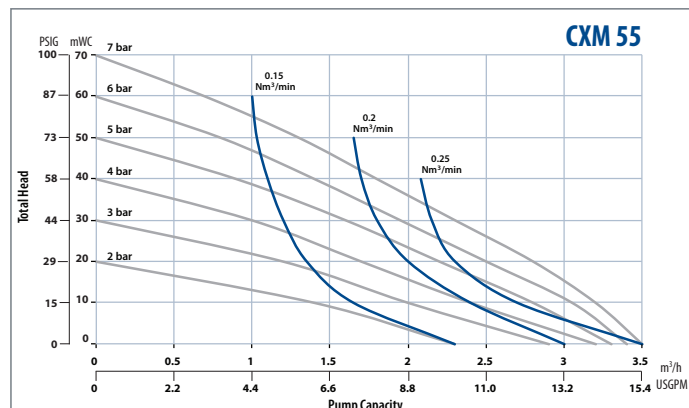
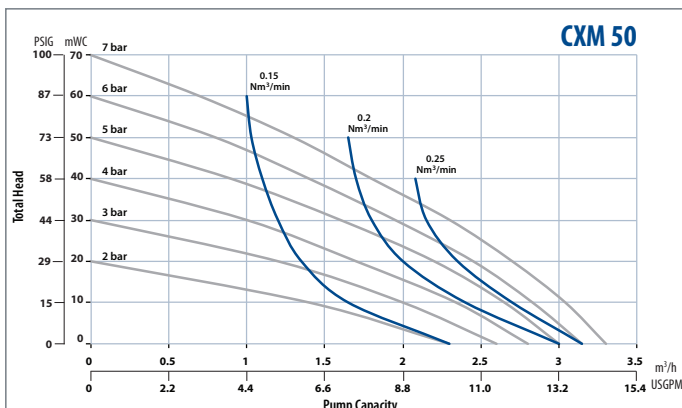
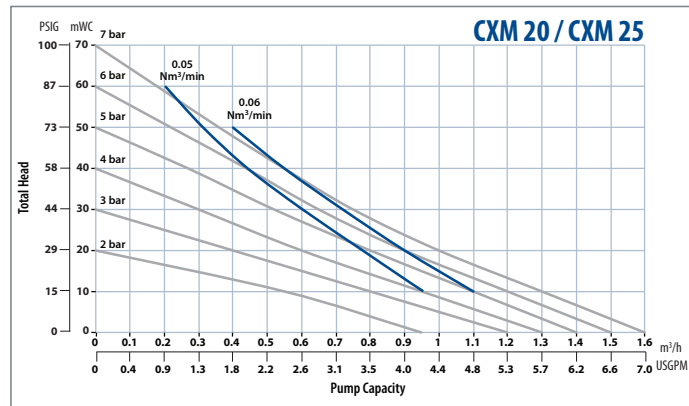
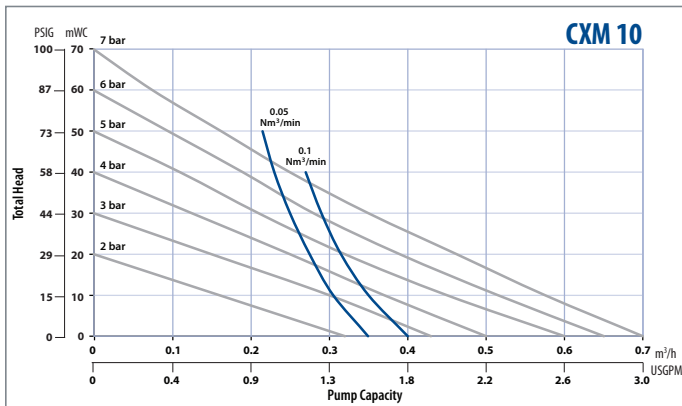

The data refers to water (20°C, 68°F), under use of different pump variations, a compressor Atlas Copco VSG30 and calibrated measuring equipment.

The specified performance data are warranted by Almatec in accordance with DIN EN ISO 9906. The blue lines state the air consumption (in Nm³/min, independent from the pressure).

ALMATEC®

PSG Germany GmbH
Hochstraße 150-152
47228 Duisburg, Germany
P: +49 (0) (2065) 89205-0
info@almatec.de
almatec.de



Where Innovation Flows

ALM-60100-C-03-A4

Authorized PSG® Partner:

Copyright 2021 PSG®, a Dover company