

xylem
Let's Solve Water

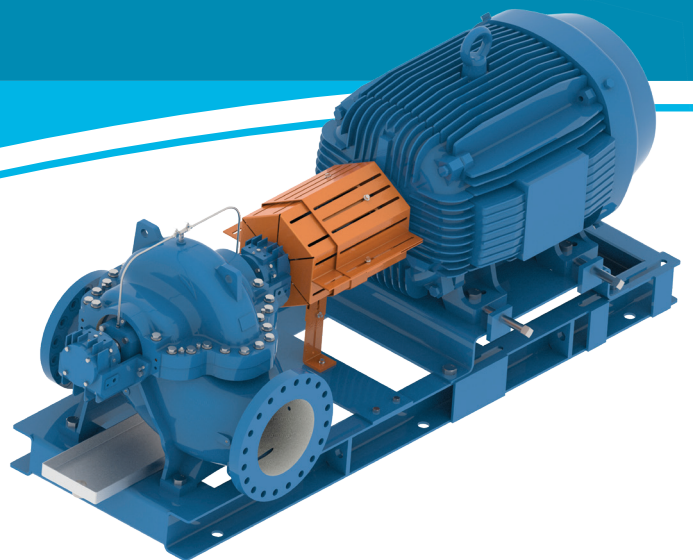

e-XC Single Stage, Double Suction Centrifugal Pumps

RAISE YOUR EXPECTATIONS WITH THE IMPROVED DOUBLE SUCTION CENTRIFUGAL PUMP THAT DELIVERS MORE



Expect more with Xylem e-XC pumps

With more models and more material options, the Xylem e-XC single stage, double suction split case pump offers a broader hydraulic range and higher efficiency than our previous models. Built on a legacy of pump innovation, the e-XC replaces the AC Series 8100, 8300 and 9100 pump range. With flow rates exceeding 57,000 gpm, it can easily handle medium and large capacity systems and higher head. Manage extra-large applications with Xylem's A-C Custom pump range.

Improved design and standard materials, as well as new proprietary mechanical seal options, take the e-XC beyond other pumps to increase operating efficiency, extend pump life and reduce lifecycle costs. More than 140 models make it easy to customize your e-XC split case pump to handle water and fluid management challenges for even the most demanding industrial applications. Backed by more than 170 years of experience and built in the U.S., the e-XC is industrial-strength thinking made real.



**POWER
GENERATION**



OIL & GAS



**GENERAL
MANUFACTURING**



POOL & LEISURE



MINING



WATER UTILITIES

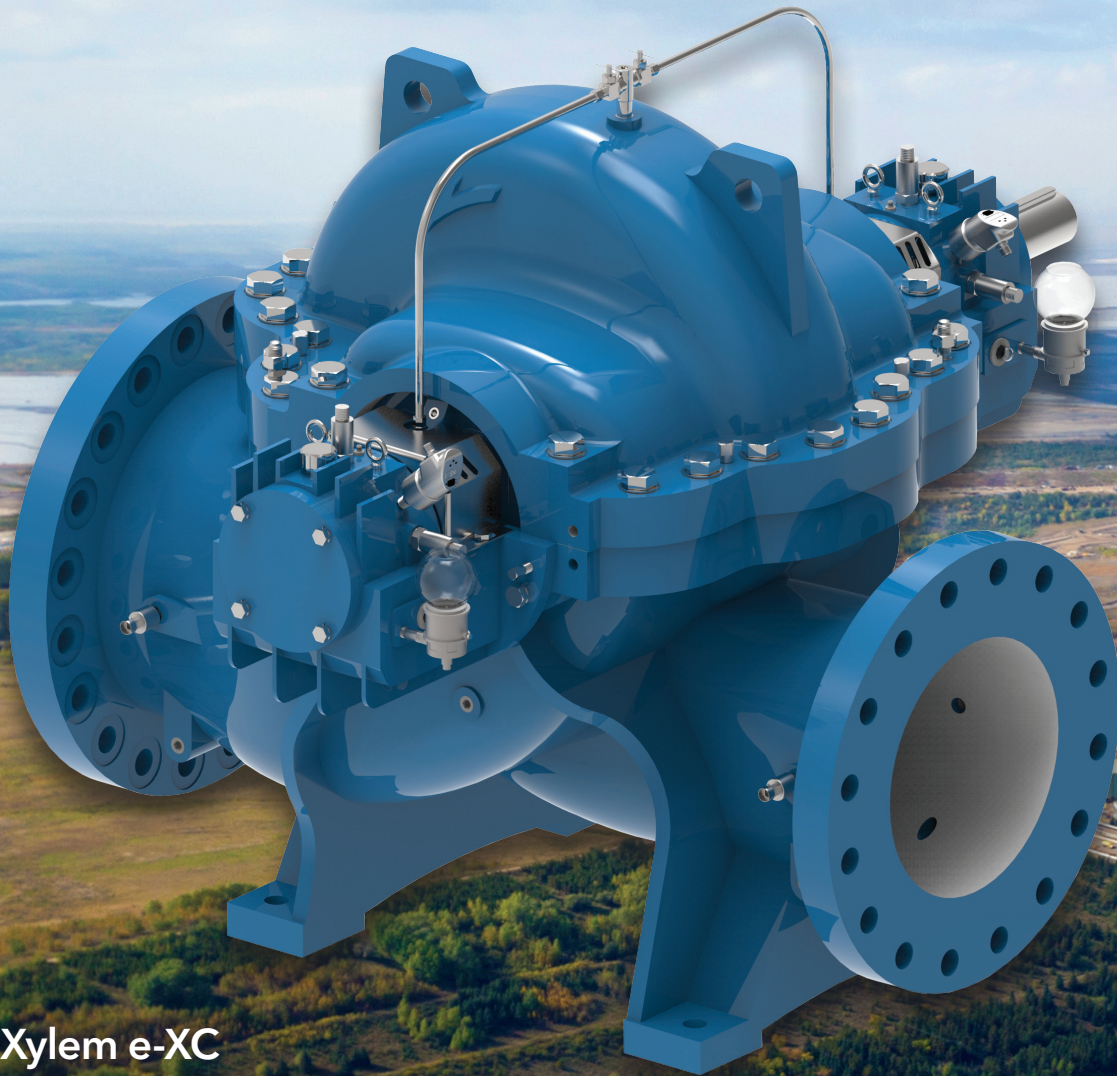

The Xylem e-XC
split case pump replaces:

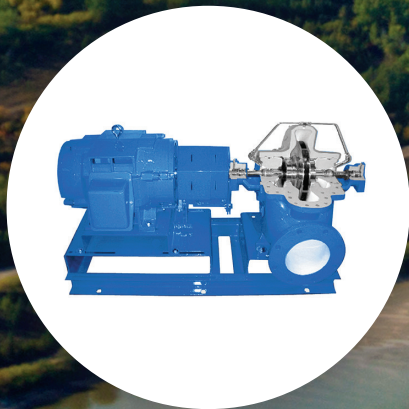

AC Series 8100

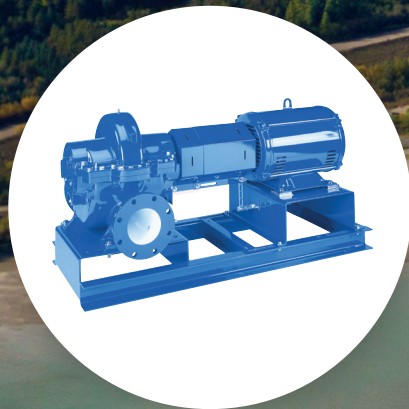

AC Series 8300

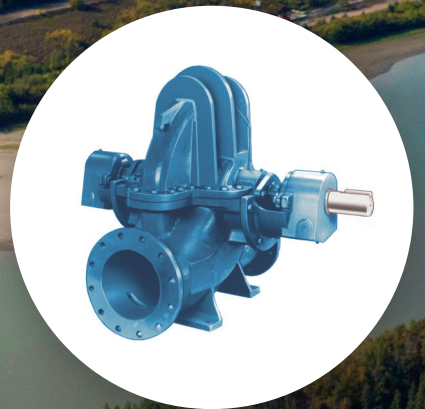

AC Series 9100

More Choices to Create Exactly the Right Pump

Engineer your pump by choosing from a full range of models, sizes and standard materials. For more aggressive applications, select upgrades including 316, Duplex and Super Duplex stainless steel for even greater corrosion resistance. You get a pump that's right for your application—with simplified installation for new or retrofit systems.

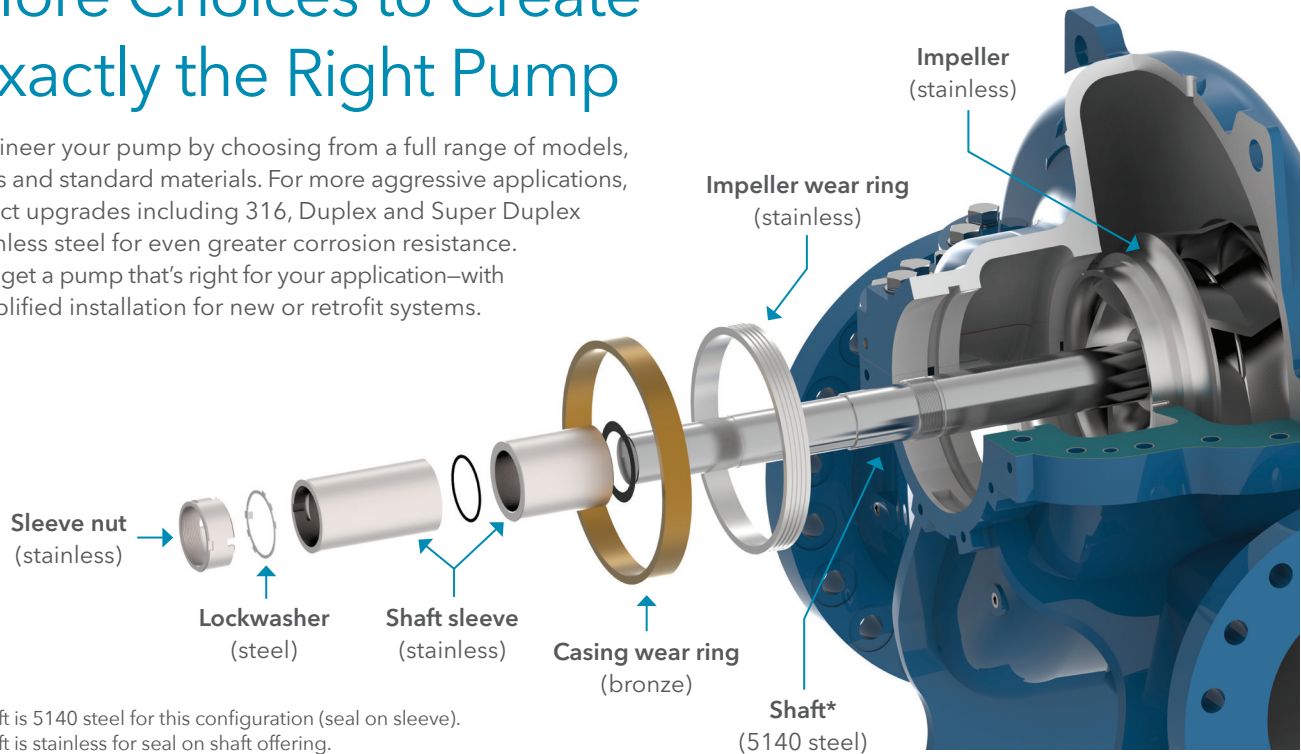

*Shaft is 5140 steel for this configuration (seal on sleeve).
Shaft is stainless for seal on shaft offering.

Component	Standard Option	Other Available Options
Casing ¹	<ul style="list-style-type: none"> Cast Iron No. 35 Ductile Iron 65-45-12 	<ul style="list-style-type: none"> 316 SS Duplex SS Super Duplex
Shaft (seal on shaft) ²	<ul style="list-style-type: none"> 420 SS 	<ul style="list-style-type: none"> Duplex SS
Shaft (seal on sleeve)	<ul style="list-style-type: none"> 5140 	<ul style="list-style-type: none"> 4135
Impeller	<ul style="list-style-type: none"> 304 SS 	<ul style="list-style-type: none"> 316 SS Duplex SS Super Duplex
Casing wear rings	<ul style="list-style-type: none"> Bronze C90300 	<ul style="list-style-type: none"> 304 SS 316 SS Duplex SS Super Duplex Nitronic 60
Impeller wear rings	<ul style="list-style-type: none"> 304 SS 	<ul style="list-style-type: none"> 316 SS Duplex SS Super Duplex Super Duplex
Shaft sleeves	<ul style="list-style-type: none"> 304 SS 	<ul style="list-style-type: none"> 316 SS Duplex SS
Shaft sleeve nuts	<ul style="list-style-type: none"> 304 SS 	<ul style="list-style-type: none"> 316 SS Duplex SS

¹Specified according to ASTM A48 or A536 standards

²Optional component with a standard material configuration

The improved design and standard materials of the e-XC rival other pumps' upgrade options.

Standard e-XC features include:

- 304 stainless steel impeller to resist corrosion
- Carbon/silicon carbide seal with an EPDM elastomer increases durability and expands application range
- Impeller wear rings and casing wear rings protect vital pump components and reduce downtime
- Shorter shaft extends running life
- Motor alignment screws simplify motor and coupling installation
- Integrated measurement ports accept optional temperature and vibration sensors, to help predict maintenance needs



More Opportunities to Extend Seal Life

Minimize leakage, protect equipment from excessive wear, lower pump maintenance costs and increase long-term cost-effectiveness with our new proprietary seals. The e-XC pump comes standard with a durable carbon/silicon carbide seal with an EPDM elastomer. This pairing enhances durability and expands the application range, or choose from a wide range of seal types and materials to fit your industrial water and fluid needs.

More Support to Promote Confidence

Xylem e-XC single stage, double suction centrifugal pumps come in so many models and materials that you can precisely configure your pump for your system. Simplify selection with our Intellitronic X selection tool. Easily configure hydraulics, pump materials, motors and seals based on your application. We'll assemble your pump and get it on its way.

Since the proper selection and configuration of your pump is critical to long-term efficiency and dependability, you also have easy access to our pump application engineers and vast network of knowledgeable distributors. They will ensure your pump is optimized for your application and designed to deliver the long-lasting, reliable service that you expect.

Technical Specifications:

- Number of models: 142
- Maximum flow: 57,061 gpm
- Maximum head: 873 ft.
- Flow discharge: up to 32"
- Nominal pressure: 175psi up to 450psi
- Flange rating: Standard #125 and #250 design
- Temperature range: -4°F to 250°F
- Available in 60Hz and 50Hz
- Standard mechanical seals: rubber bellow or balanced metal pusher
- Optional seals: packing, cartridge or custom solutions
- Eight (8) standard alignment jacking screws for easier motor alignment (NEMA 215 motor frame size and larger)
- Three (3) vibration ports 1/4-28 UNF
- Two (2) temperature ports 1/4 MNPT

More Sizes Equals More Opportunities

Performance Comparison to Previous Models

The e-XC split case pump offers a broader hydraulic range, better efficiency and more sizes than previous models. More sizes equals more opportunities to optimize efficiency for your application. Whether your system requires small or large capacity, we have the right pump for you.

60 Cycle - 890 rpm

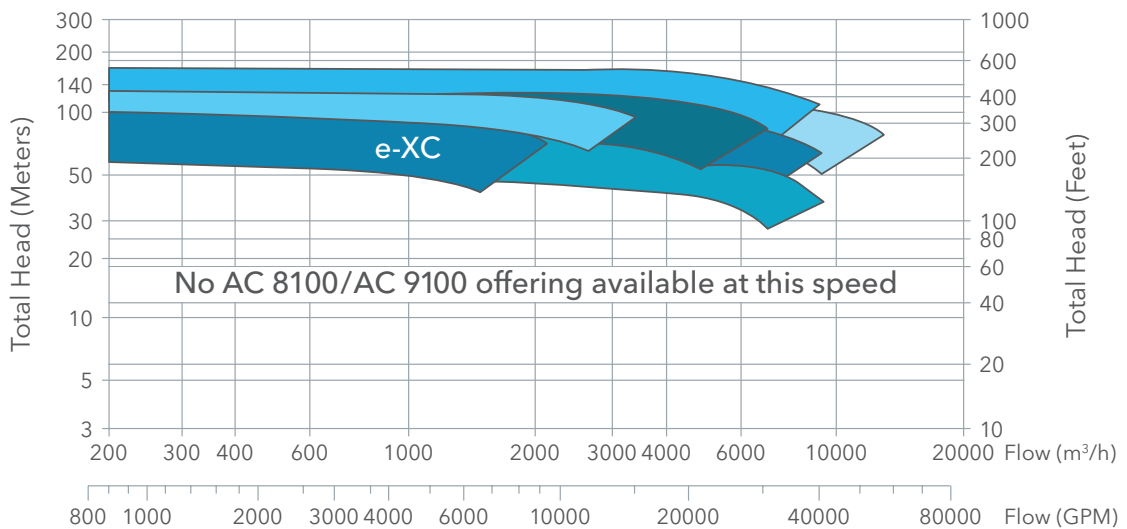

60 Cycle - 1180 rpm

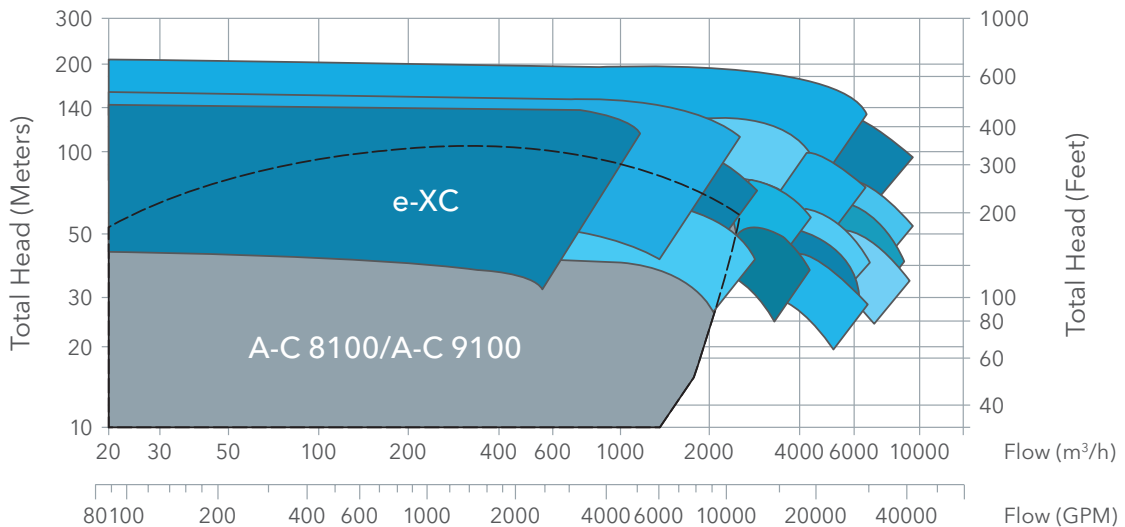

60 Cycle - 1780 rpm

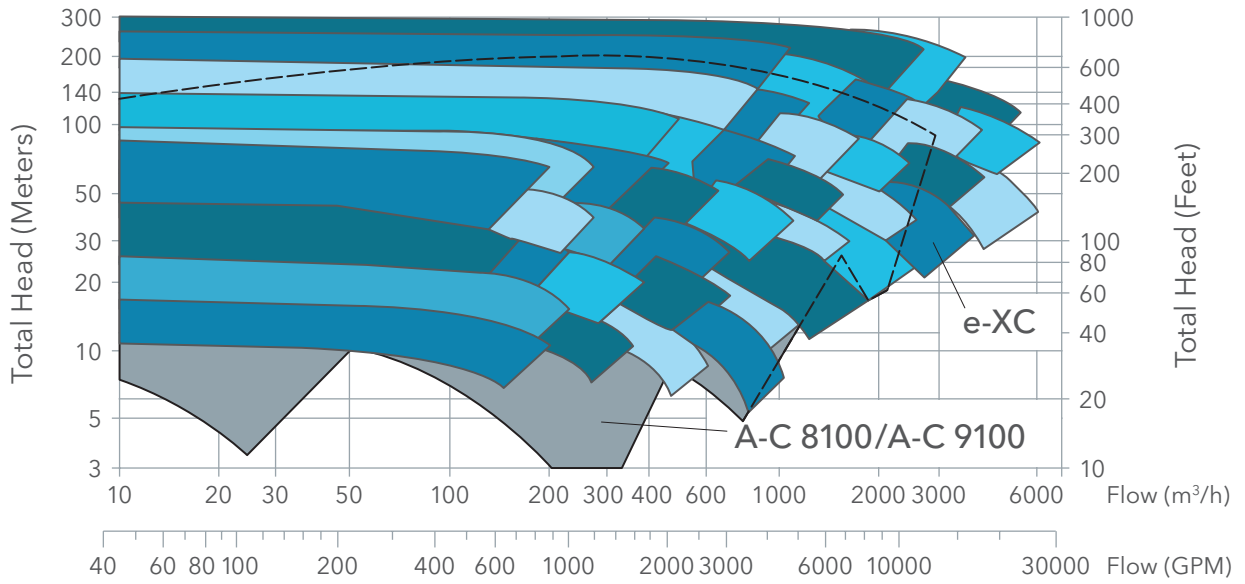

60 Cycle - 3560 rpm

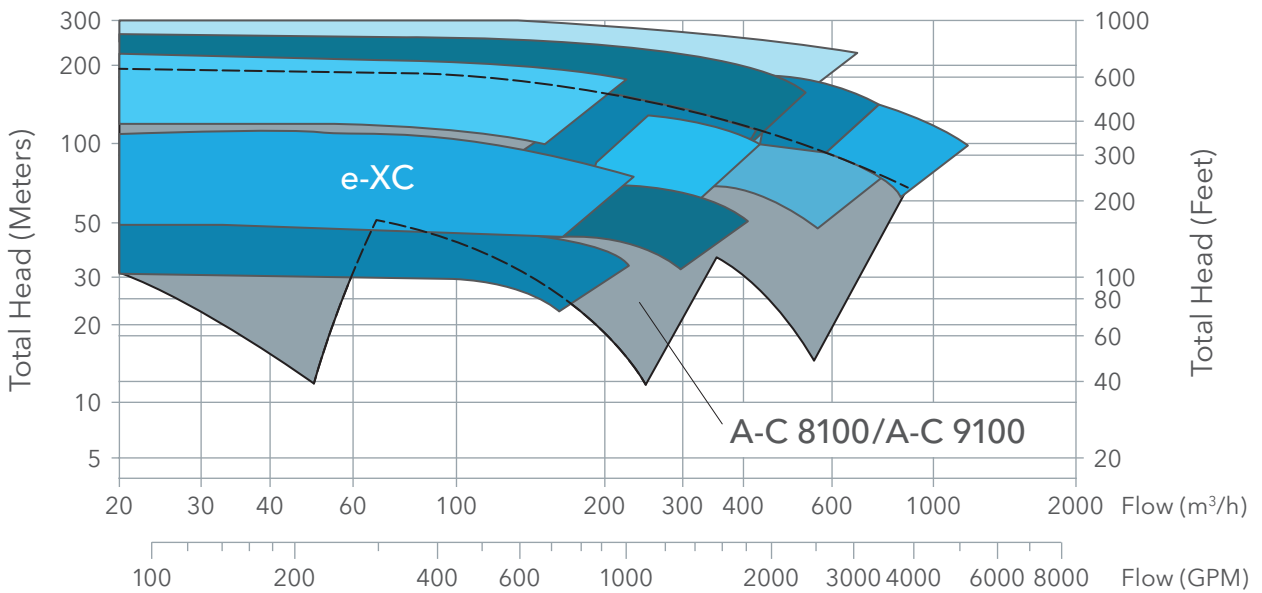

More Features to Improve Performance, Efficiency—and Your Bottom Line

1 Mechanical Seal Extends Life

Introducing Xylem's proprietary mechanical seals, in a wide range of types and materials to handle critical industrial applications. Durable carbon/silicon carbide with EPDM elastomer seal is standard.

2 Stainless Steel Impeller Reduces Downtime

Standard 304SS impeller resists corrosion from process fluids to boost performance. For more aggressive applications, upgrade to 316, Duplex, or Super Duplex stainless steel.

3 Impeller and Casing Wear Rings Increase Efficiency

Standard wear rings protect against abrasion and debris, reduce downtime and simplify maintenance while avoiding costly impeller or casing replacement. Impeller wear rings are standard with any impeller combination.

4 Casing Material Options Add Flexibility

Standard casing options include cast iron or ductile iron. Customize with 316, Duplex, or Super Duplex stainless steel to meet your operating environment demands.

5 Labyrinth Seal Strengthens Protection

A bearing frame labyrinth seal comes standard, protecting against wear, heat, frictional power loss and debris. Prevent leakage and ensure a cleaner, safer work environment while minimizing maintenance and extending pump life.

6 Monitoring Ports Increase Visibility

Every e-XC pump contains dual axis vibration and temperature sensor ports, as standard. Optional sensor interfaces can be connected to plant control systems for enhanced monitoring and diagnostics. Catch issues early to prevent failures and provide peace of mind.

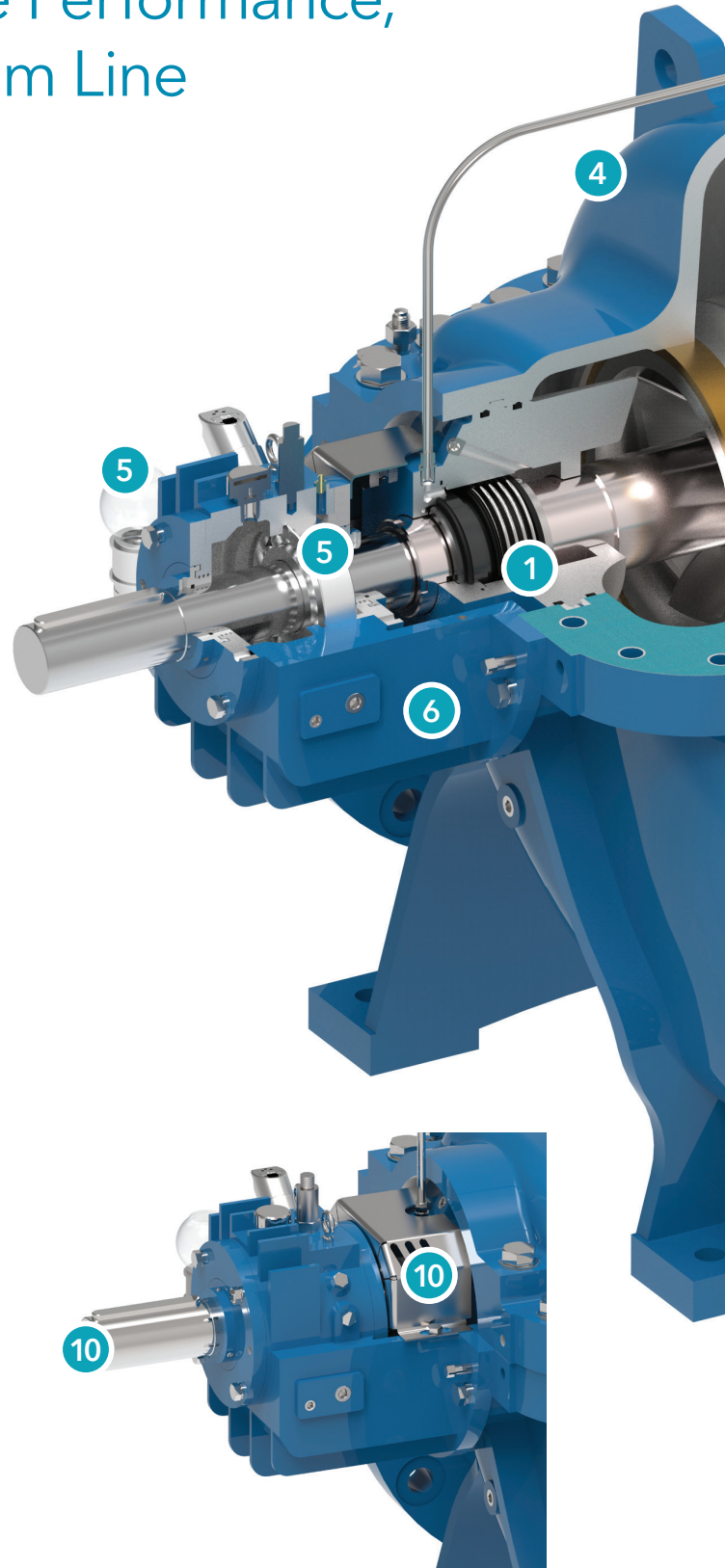

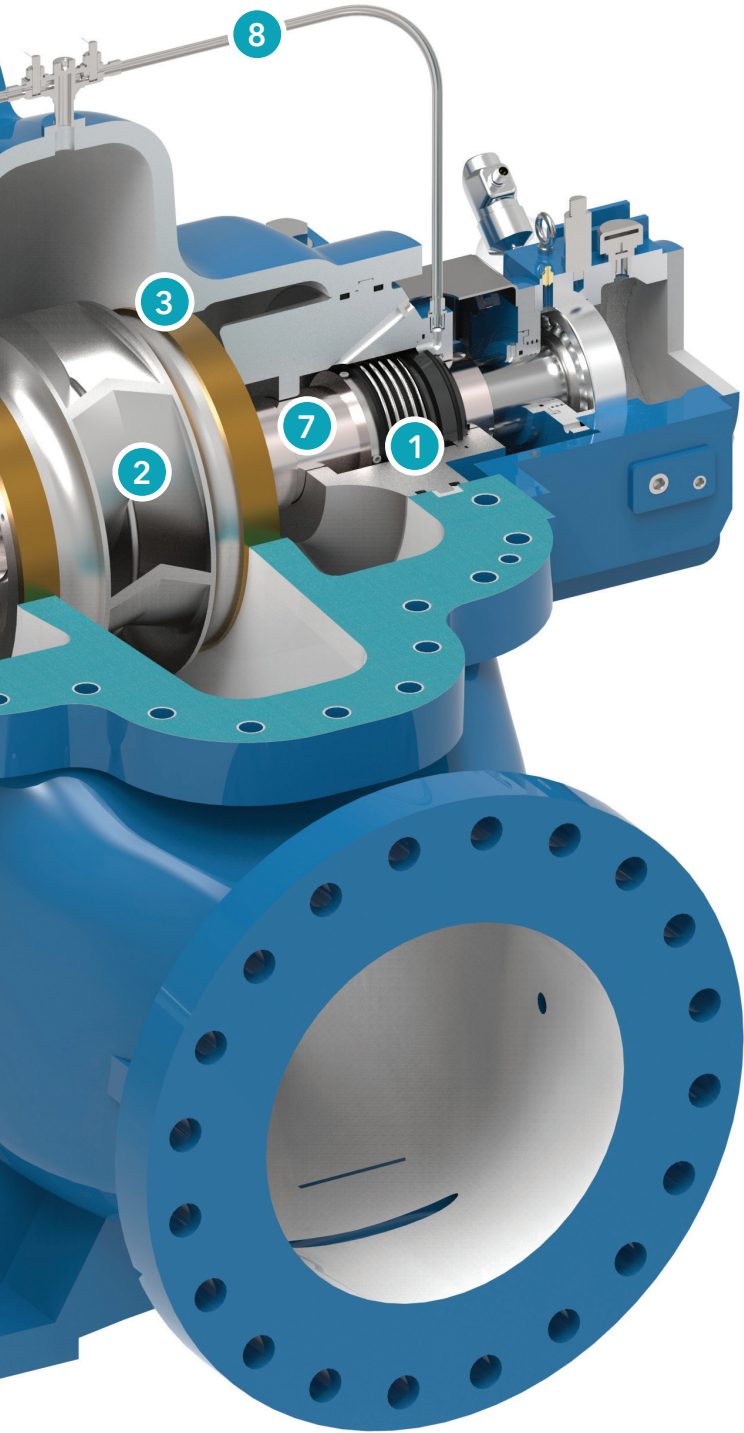

7 Shaft Sleeve Minimizes Repair Costs

Easily replaced sleeves minimize shaft wear from corrosive and abrasive liquids, reducing repair and/or replacement costs. Standard is 304 stainless steel; upgrade to 316, Duplex, or Super Duplex stainless steel for aggressive environments.

8 Flush Line Extends Seal Life

Robust, corrosion-resistant stainless steel external flush line makes it easy to clean and cool the mechanical seal, extending seal life. Standard is 304 stainless steel; upgrade to 316 for more demanding applications.

9 Motor Alignment Screws Speed Up Installation

Eight standard screws take the hassle out of motor and coupling installation.

10 Shaft and Coupling Guards Support Safety

Ensure safety despite exposed shaft design at no extra cost. Durable powder coating resists scratches and better maintains metal surfaces. Guard components reduce noise while protecting operators from high-speed rotating elements.

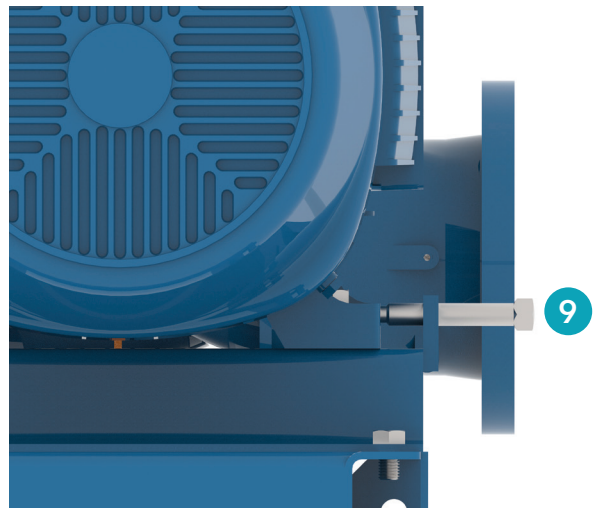

More Control with Enhanced Monitoring and Sensors

Opportunities to cut pump energy use include smart hydraulic system design, retrofitting for variable speed performance, and operating practices. To build and operate an efficient water system, you need both the right products and experts who know the application. Aquavar® IPC controllers have been designed by Xylem's engineers to help you achieve your goals. With the help of the Aquavar IPC variable speed controller, you can optimize pump operations and reduce energy costs by as much as 70%.

Aquavar IPC variable speed controller

The Aquavar® IPC variable speed controller is optimized for e-XC pumps, adding capabilities including multipump configuration and remote monitoring. This controller manages pump energy consumption, leading to significant energy savings.



Features

- Easier start-up and programming with Start-Up Genie
- Wide range of standard and permanent magnet motors with power up to 600 hp
- Multi-pump configuration for up to four (4) pumps - no need for PLC
- Remote commissioning and monitoring with USB Connectivity and software
- Developed by pump experts and optimized for controlling pumps
- Two wire multi-pump connection for faster installation
- Hand on, off, and auto-on buttons available for easy pump operation at the keypad. No toggling between local and remote operation
- System redundancy with multi-master control in case of drive failure
- Wide range of voltage and enclosure options
- True 208 V coverage
- Dedicated single phase input
- In-panel or handheld keypad with backlit display
- Alarm Log for last 5 alarms and maintenance events
- EMC/RFI filters and Dual DC-link reactors to reduce drive noise emissions and interference
- I/O expansion cards, factory installed or field configured

More Visibility Providing Peace of Mind

Every e-XC pump contains dual axis vibration and temperature sensor ports to help manage the operating efficiency of your pump and establish preventative maintenance protocols. Multiple sensor monitoring ports for pressure, vibration and temperature are standard. Sensors are also available as optional accessories for added pump condition monitoring.



More Options to Suit Even More Applications



POWER GENERATION



OIL & GAS



**GENERAL
MANUFACTURING**



POOL & LEISURE



MINING



WATER UTILITIES

For more than a century, Xylem's pump technologies and solutions have satisfied customers all over the world. The e-XC pump continues that tradition, taking industrial thinking to a new level with more options, more materials and a broader hydraulic range. Here are just a few of the markets and applications where we're helping customers solve their most complex water and fluid management challenges.

Applications

- Water intake
- Water transfer and circulation
- Pressure boosting
- Process cooling and heating
- Industrial building cooling and heating
- Industrial fluid transfer and transport
- Produced water transfer and boosting
- Boiler feed booster
- Water park applications

Pumped Fluids

- Groundwater
- Potable water
- Process water
- Gray/used water
- Seawater
- Brackish water
- Industrial fluids
- Heat transfer fluids
- Produced water
- Solvents/oil

Xylem |'zīləm|

- 1) The tissue in plants that brings water upward from the roots;
- 2) a leading global water technology company.

We're a global team unified in a common purpose: creating advanced technology solutions to the world's water challenges. Developing new technologies that will improve the way water is used, conserved, and re-used in the future is central to our work. Our products and services move, treat, analyze, monitor and return water to the environment, in public utility, industrial, residential and commercial building services settings. Xylem also provides a leading portfolio of smart metering, network technologies and advanced analytics solutions for water, electric and gas utilities. In more than 150 countries, we have strong, long-standing relationships with customers who know us for our powerful combination of leading product brands and applications expertise with a strong focus on developing comprehensive, sustainable solutions.

For more information on how Xylem can help you, go to www.xylem.com



Xylem Inc.
Phone: (866) 673-0428
Fax: (888) 322-5877
www.xylem.com/industrial

All other trademarks or registered trademarks are property of their respective owners.
© 2019 Xylem BRexC_12PG June 2019